

Edvo-Kit #

105

Edvo-Kit #105

Mapping of Restriction Sites on Plasmid DNA

Experiment Objective:

The objective of this experiment module is to develop an understanding of the principles of DNA mapping using various restriction enzymes to generate DNA fragments.

See page 3 for storage instructions.

Version 105.210628

EDVOTEK®

Table of Contents

	Page
Experiment Components	3
Experiment Requirements	3
Background Information	4
Experiment Procedures	
Experiment Overview	6
Module I: Agarose Gel Electrophoresis	9
Module II: Staining Agarose Gels Using FlashBlue™	11
Module III: Size Determination of DNA Restriction Fragments	12
Module IV: Mapping of DNA Restriction Sites	15
Study Questions	16
Instructor's Guidelines	17
Pre-Lab Preparations	18
Experiment Results and Analysis	20
Study Questions and Answers	21
Appendices	22
A EDVOTEK® Troubleshooting Guide	23
B Bulk Preparation of Electrophoresis Buffer and Agarose Gels	24
C Using SYBR® Safe Stain (OPTIONAL)	25

Safety Data Sheets can be found on our website: www.edvotek.com/safety-data-sheets

Technical Support

1.800.EDVOTEK

Mon. - Fri. 8 AM to 5:30 PM EST



Please Have the Following Info:

- Product Number & Description
- Lot Number on Box
- Order/Purchase Order #

1.800.EDVOTEK • info@edvotek.com • www.edvotek.com

www.edvotek.com

- Online Catalog
- Order Products
- Experiment Protocols
- Tech Support
- Resources!



EDVOTEK and The Biotechnology Education Company are registered trademarks of EDVOTEK, Inc. Ready-to-Load, QuickStrip, FlashBlue, and UltraSpec-Agarose are trademarks of EDVOTEK, Inc. SYBR is a registered trademark of Thermo Fisher Scientific.



Experiment Components

READY-TO-LOAD™ SAMPLES FOR ELECTROPHORESIS

Components (in QuickStrip™ format)

Store QuickStrip™ samples in the refrigerator upon receipt.

	Check (✓)
A DNA Standard Marker	<input type="checkbox"/>
B Plasmid cut with Enzyme 1	<input type="checkbox"/>
C Plasmid cut with Enzyme 2	<input type="checkbox"/>
D Plasmid cut with Enzyme 1 and Enzyme 2	<input type="checkbox"/>

Experiment #105 is designed for 8 groups.

Store QuickStrip™ samples in the refrigerator immediately upon receipt. All other components can be stored at room temperature.

REAGENTS & SUPPLIES

Store the following at room temperature.

• UltraSpec-Agarose™	<input type="checkbox"/>
• Electrophoresis Buffer (50x)	<input type="checkbox"/>
• Practice Gel Loading Solution	<input type="checkbox"/>
• FlashBlue™ DNA Stain	<input type="checkbox"/>

Requirements

- Horizontal gel electrophoresis apparatus
- D.C. power supply
- Automatic micropipettes with tips
- Balance
- Microwave, hot plate or burner
- Pipet pump
- 250 mL flasks or beakers
- Hot gloves
- Safety goggles and disposable laboratory gloves
- Small plastic trays or large weigh boats (for gel destaining)
- DNA visualization system (white light)
- Distilled or deionized water

All experiment components are intended for educational research only. They are not to be used for diagnostic or drug purposes, nor administered to or consumed by humans or animals.

Background Information

The Human Genome and other genome projects are extremely significant accomplishments with important applications to biology and medicine. The explosion of this new information is leading to dramatic changes in the way we are able to improve life. Part of the challenge in dealing with the enormous amounts of data is to determine what genes are responsible for different functions. Scientists must determine the location of genes through DNA mapping, and then begin the arduous task of determining what the individual genes do.

Mapping the positions of restriction enzyme cleavage sites on a DNA molecule is an important prerequisite to DNA sequencing, which provides the primary nucleotide sequence information in DNA. Mapping involves the determination of the relative distances between restriction enzyme cleavage sites. An illustrative analogy would be somewhat similar to the following: If DNA mapping were compared to identifying the streets on a city map, then DNA sequencing would be analogous to identifying the specific houses on the streets.

DNA mapping is performed by determining the size of the DNA fragments generated by single or combinations of restriction enzyme digestions, and subsequent construction of a DNA map. For example:

- Consider a 5000 base pair, circular plasmid DNA containing single recognition sites for enzymes A, B, and C (Figure 1).
- Going in a clockwise direction from A, the distances between

A and B is 500
 B and C is 1500
 C and A is 3000

These assignments are made based on the size of the entire circular plasmid, which is 5,000 base pairs (Figure 2).

To obtain a reference point, the cleavage site at A will be arbitrarily assigned as position zero. All three enzymes will cleave the plasmid once to produce a linear molecule of 5000 base pairs. Different combinations of these enzymes will produce the following DNA fragments (in base pairs):

A+B	A+C	B+C	A+B+C
4500	3000	3500	3000
500	2000	1500	1500
			500

This data shows that the cleavage site at B is closest to A since cleavage A+B generated the smallest fragment (500) out of all the

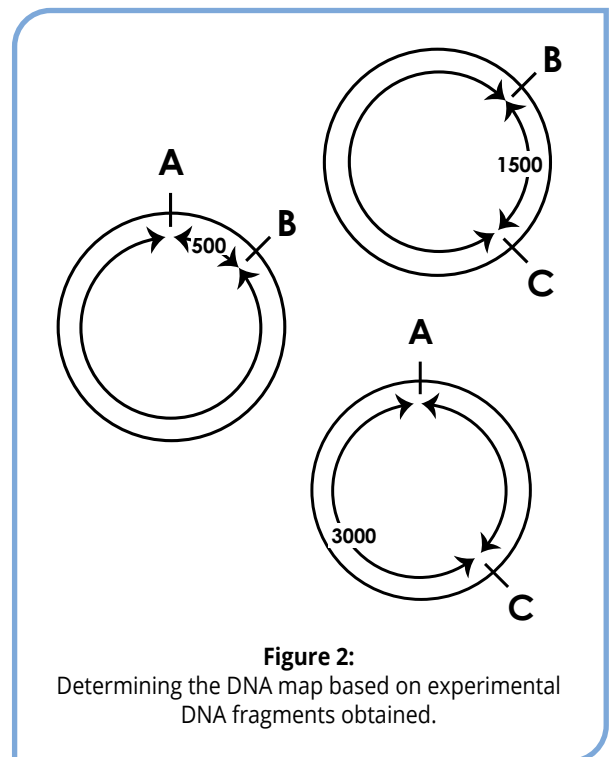
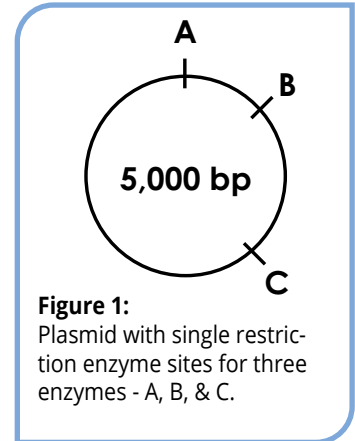

pairs of enzymes. The shortest distance between A and C is 2000 base pairs since the smallest fragment in the A + C pair is 2000. Similarly, the shortest distance between B and C is 1500 base pairs. It remains to be determined if B is in between A and C (Figure 1) or alternatively, B is between C and A (going in a clockwise direction from A around the plasmid, Figure 3).

If C was in between A and B, the 500 base pair fragment would have been cleaved into two smaller fragments. However, when all three enzymes are used, the 500 base pair fragment remains. In addition, only the 2000 base pair fragment found in the A + C pair is cleaved into 1500 and 500 base pair fragments when all three enzymes are used, verifying the location of B. This kind of logic enables the construction of a map, as previously shown, from DNA fragment sizes.

Note that the data from this experiment cannot tell us the absolute orientation of the cleavage sites since it can lead to an alternative map as shown in Figure 2. However, the relative positions are still the same (B is in between A and C). The assignment (Figure 1 or Figure 3) can be made upon further analysis.

Unknown DNA fragment sizes are determined by comparing the relative mobilities of DNA fragments of known size as standards. DNA fragments, from plasmid digests, and standard DNA fragments (also known as markers) are electrophoretically separated in parallel on the same agarose gel. After electrophoretic separation, DNA fragments are stained for visualization, and migration distances of known and unknown fragments are measured.

Standard fragments are used to make a standard curve by plotting their size on the y-axis versus the migration distance on the x-axis. The size of the fragments on the y-axis are expressed as the log of the number of base pairs they contain or the log of their molecular weight. Most of the plotted data obtained from the markers will yield a straight line. The migration distance of the unknown DNA fragment(s) are located on the X-axis and their size is estimated from the standard curve.

After determining the size of the DNA fragments generated by single and combinations of restriction enzymes, a DNA map is constructed as previously described.

In this experiment, you will determine the relative locations of three restriction enzyme cleavage sites on a circular plasmid DNA. The plasmid has been cleaved with three restriction enzymes. Enzyme 1 cleaves the plasmid once at site A. Assume that the Enzyme 1 site is at position 0. Enzyme 2 and 3 also cut the plasmid once at sites B and C. The objective is to calculate the distances in base pairs between the points of cleavage and to determine whether the Enzyme 1 site is in between the Enzyme 2 sites.

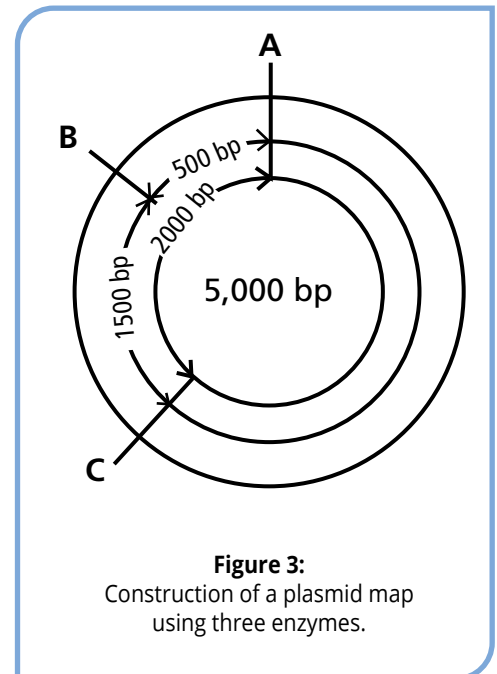

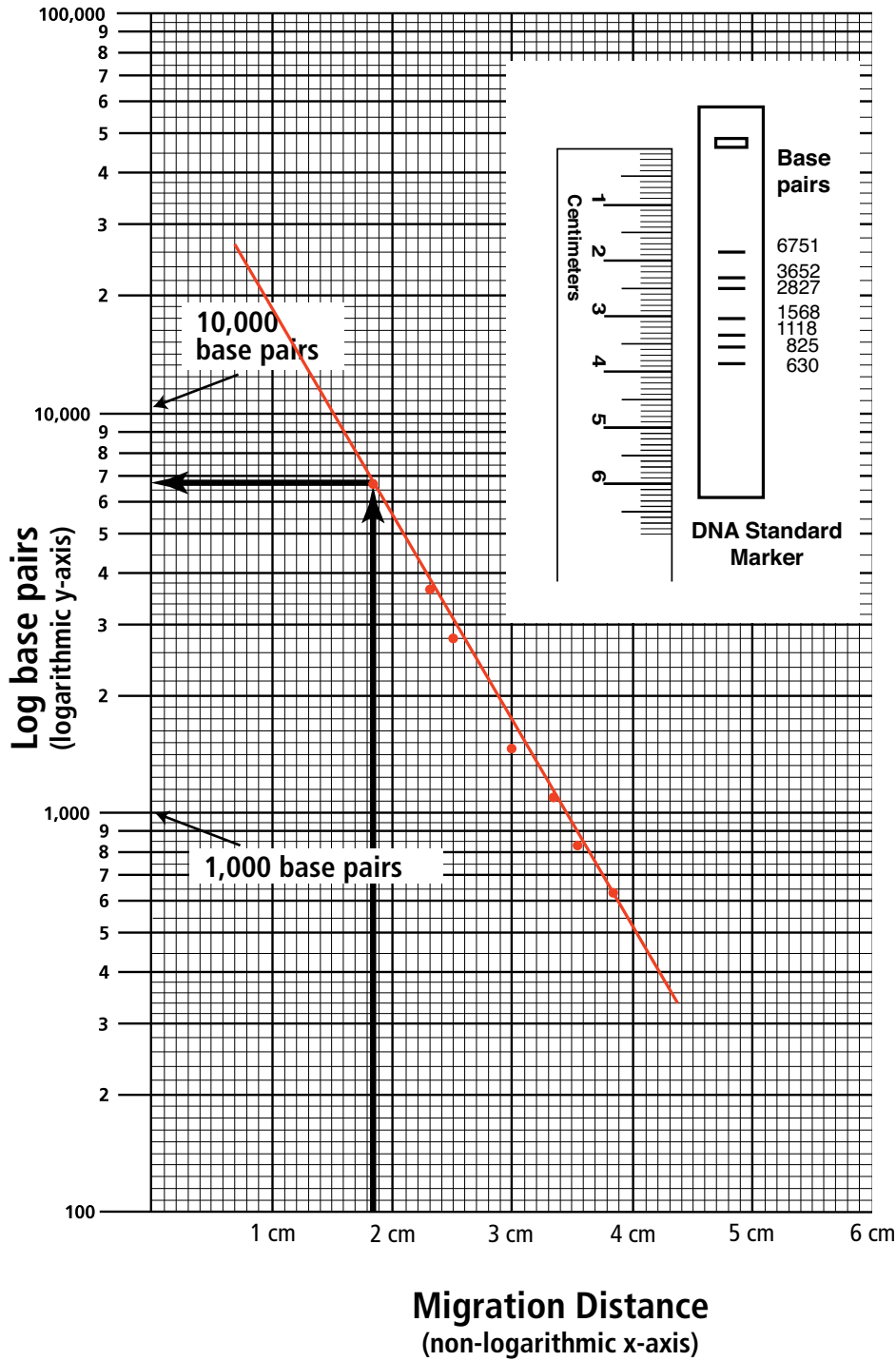

Quick Reference:

Standard DNA fragments, which were generated by restriction enzymes are provided in this experiment (DNA Standard Marker). A standard curve will be plotted on semi-log graph paper. The following Standard DNA fragment sizes are expressed in base pairs.

6751, 3652, 2827, 1568, 1118, 825, 630

Experiment Overview

EXPERIMENT OBJECTIVE

The objective of this experiment module is to develop an understanding of the principles of DNA mapping using various restriction enzymes to generate DNA fragments.

LABORATORY SAFETY

1. Gloves and goggles should be worn routinely as good laboratory practice.
2. Exercise extreme caution when working with equipment that is used in conjunction with the heating and/or melting of reagents.
3. DO NOT MOUTH PIPET REAGENTS - USE PIPET PUMPS.
4. Exercise caution when using any electrical equipment in the laboratory.
5. Always wash hands thoroughly with soap and water after handling reagents or biological materials in the laboratory.



LABORATORY NOTEBOOKS

Scientists document everything that happens during an experiment, including experimental conditions, thoughts and observations while conducting the experiment, and, of course, any data collected. Today, you'll be documenting your experiment in a laboratory notebook or on a separate worksheet.

Before starting the Experiment:

- Carefully read the introduction and the protocol. Use this information to form a hypothesis for this experiment.
- Predict the results of your experiment.

During the Experiment:

- Record your observations.

After the Experiment:

- Interpret the results – does your data support or contradict your hypothesis?
- If you repeated this experiment, what would you change? Revise your hypothesis to reflect this change.

Experiment Overview

MODULE I: Agarose Gel Electrophoresis

Time required: See Table C

Quick Reference for EDVO-Kit #105			
Size of gel casting tray	Groups per gel	Placement of comb	Wells required per group
7 x 7 cm	1 group	1st set of notches	4
10 x 7 cm	1 group	1st set of notches	4
14 x 7 cm	2 groups	1st and 3rd sets of notches	4

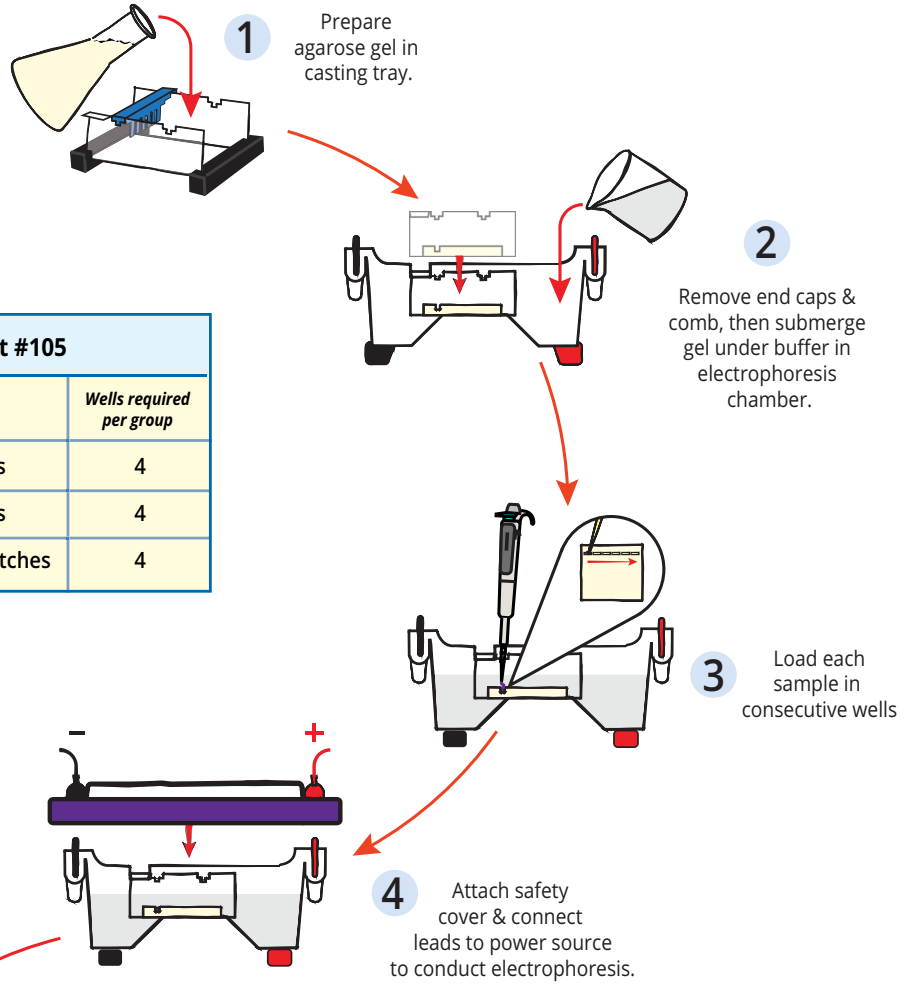

MODULE II: Staining Agarose Gels Using FlashBlue™

Time required: 30 min.

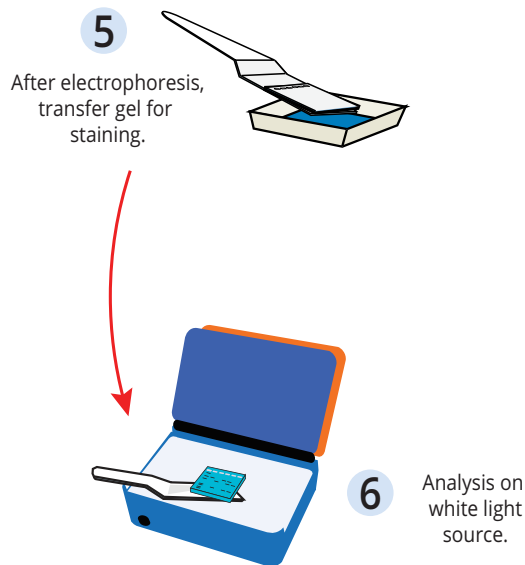

Related EDVOTEK® Instructional Videos

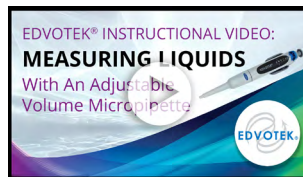

www.youtube.com/edvotekinc

Module I: Agarose Gel Electrophoresis

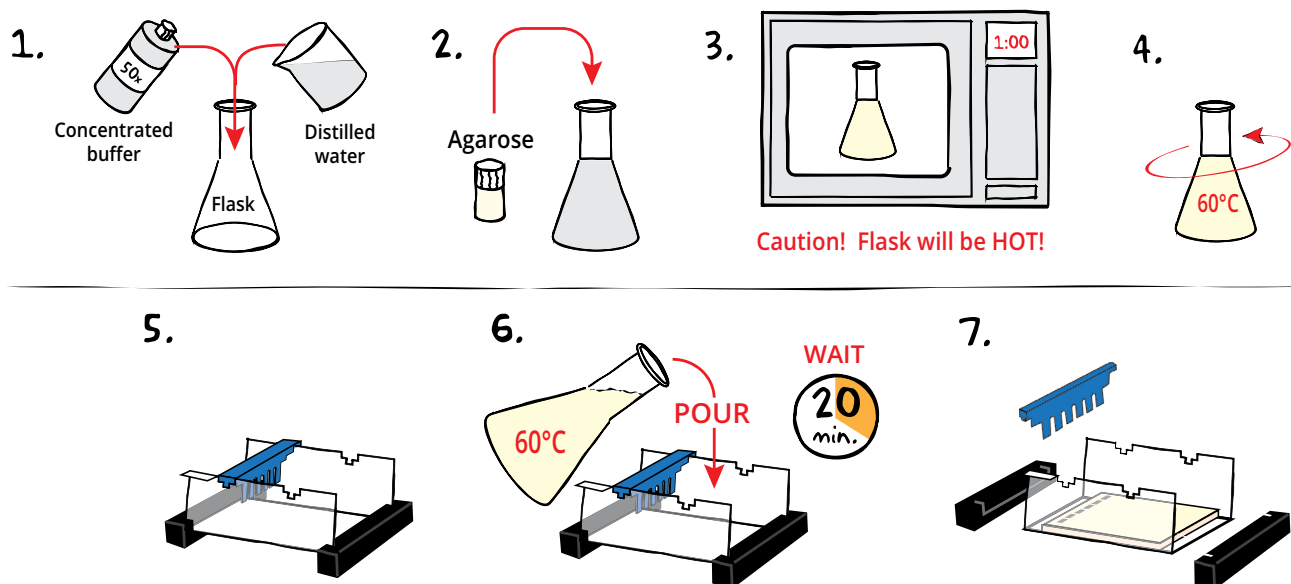

CASTING THE AGAROSE GEL

- DILUTE** concentrated 50X Electrophoresis buffer with distilled water (refer to Table A for correct volumes depending on the size of your gel casting tray).
- MIX** agarose powder with buffer solution in a 250 mL flask (refer to Table A).
- DISSOLVE** agarose powder by boiling the solution. **MICROWAVE** the solution on high for 1 minute. Carefully **REMOVE** the flask from the microwave and **MIX** by swirling the flask. Continue to **HEAT** the solution in 15-second bursts until the agarose is completely dissolved (the solution should be clear like water).
- COOL** agarose to 60 °C with careful swirling to promote even dissipation of heat.
- While agarose is cooling, **SEAL** the ends of the gel-casting tray with the rubber end caps. **PLACE** the well template (comb) in the appropriate notch.
- POUR** the cooled agarose solution into the prepared gel-casting tray. The gel should thoroughly solidify within 20 minutes. The gel will stiffen and become less transparent as it solidifies.
- REMOVE** end caps and comb. Take particular care when removing the comb to prevent damage to the wells.



Wear gloves and safety goggles

REMINDER:

This experiment requires 0.8% agarose gels cast with 6 wells.

Size of Gel Casting tray	Concentrated Buffer (50x)	+ Distilled Water	+ Amt of Agarose	= TOTAL Volume
7 x 7 cm	0.6 mL	29.4 mL	0.24 g	30 mL
10 x 7 cm*	0.9 mL	44.1 mL	0.36 g	45 mL
14 x 7 cm	1.2 mL	58.8 mL	0.48 g	60 mL

*Recommended gel volume for the EDGE™ Integrated Electrophoresis System. (Cat. #500).

Module I: Agarose Gel Electrophoresis

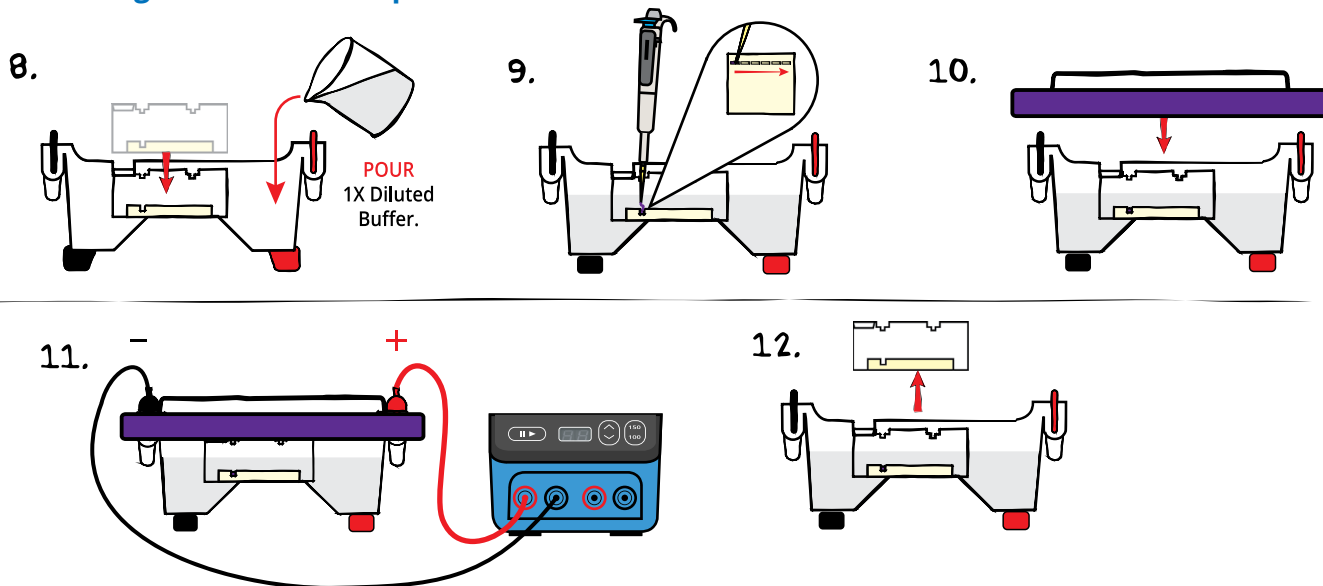

RUNNING THE GEL

8. **PLACE** the gel (still on the tray*) into the electrophoresis chamber. **COVER** the gel with 1X Electrophoresis Buffer (See Table B for recommended volumes). The gel should be completely submerged.
9. **PUNCTURE** the foil overlay of the QuickStrip™ with a pipet tip. **LOAD** the entire sample (35 µL) into the well in the order indicated by Table 1, at right.
10. **PLACE** safety cover on the unit. **CHECK** that the gel is properly oriented. Remember, the DNA samples will migrate toward the positive (red) electrode.
11. **CONNECT** leads to the power source and **PERFORM** electrophoresis (See Table C for time and voltage guidelines). Allow the tracking dye to migrate at least 3 cm from the wells.
12. After electrophoresis is complete, **REMOVE** the gel and casting tray from the electrophoresis chamber.

REMINDER:
Before loading the samples, make sure the gel is properly oriented in the apparatus chamber.

Lane	Tube	Sample
1	Tube A	DNA Standard Marker
2	Tube B	Plasmid cut with Enzyme 1
3	Tube C	Plasmid cut with Enzyme 2
4	Tube D	Plasmid cut with Enzymes 1 and 2

PROCEED to Module II: Staining Agarose Gels Using FlashBlue™.

EDVOTEK Model #	Total Volume Required	Dilution	
		50x Conc. Buffer	+ Distilled Water
EDGE™	150 mL	3 mL	147 mL
M12	400 mL	8 mL	392 mL
M36	1000 mL	20 mL	980 mL

Volts	Electrophoresis Model	
	EDGE™	M12 & M36
	Min/Max (minutes)	Min/Max (minutes)
150	10/20	20/35
125	N/A	30/45
100	15/25	40/60

*Gels that have previously been removed from their trays should be "anchored" back to the tray with a few drops of molten agarose before placing into the electrophoresis chamber. This will prevent the gels from sliding around in the trays and the chambers.

Module II: Staining Agarose Gels Using FlashBlue™

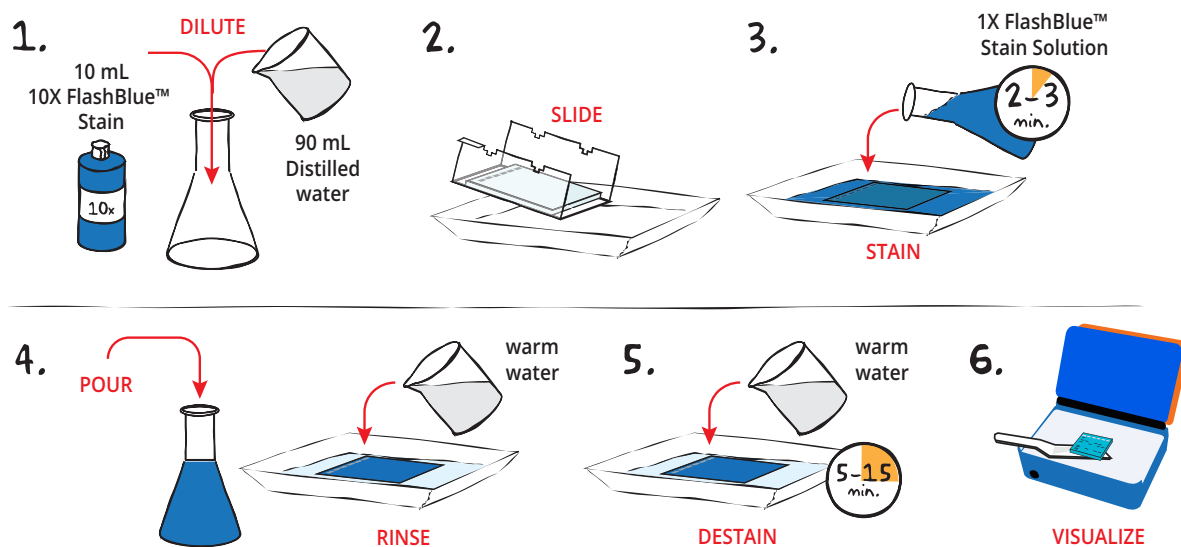

- DILUTE** 10 mL of 10X concentrated FlashBlue™ with 90 mL of distilled water in a flask. **MIX** well.
- REMOVE** the agarose gel and casting tray from the electrophoresis chamber. **SLIDE** the gel off the casting tray into a small, clean gel-staining tray.
- COVER** the gel with the 1X FlashBlue™ stain solution. **STAIN** the gel for 2-3 minutes. For best results, use an orbital shaker to gently agitate the gel while staining. **STAINING THE GEL FOR LONGER THAN 3 MINUTES WILL REQUIRE EXTRA DESTAINING TIME.**
- POUR** the 1X FlashBlue™ back into the flask (the stain can be reused). **COVER** the gel with warm water (40-45 °C). Gently **RINSE** the gel for 20-30 seconds. **POUR** off the water.
- COVER** the gel with clean, warm water (40-45 °C). **DESTAIN** for 5-15 minutes with gentle shaking (longer periods will yield better results). DNA bands will start to appear after 5 minutes of destaining. Changing the water frequently will accelerate destaining.
- Carefully **REMOVE** the gel from the destaining liquid. **VISUALIZE** results using a white light visualization system. DNA will appear as dark blue bands on a light blue background.



ALTERNATIVE FLASHBLUE™ STAINING PROTOCOL:

- DILUTE** 1 mL of 10X FlashBlue™ stain with 149 mL distilled water.
- COVER** the gel with diluted FlashBlue™ stain.
- SOAK** the gel in the staining liquid for at least three hours. For best results, stain gels overnight.
- Carefully **REMOVE** the gel from the staining liquid. **VISUALIZE** results using a white light visualization system. DNA will appear as dark blue bands on a light blue background.

Module III: Size Determination of DNA Restriction Fragments

Agarose gel electrophoresis separates biomolecules into discrete bands, each comprising molecules of the same size. How can these results be used to determine the lengths of different fragments? Remember, as the length of a biomolecule increases, the distance to which the molecule can migrate decreases because large molecules cannot pass through the channels in the gel with ease. Therefore, the migration rate is inversely proportional to the length of the molecules—more specifically, to the log₁₀ of molecule's length. To illustrate this, we ran a sample that contains bands of known lengths called a "standard". We will measure the distance that each of these bands traveled to create a graph, known as a "standard curve", which can then be used to extrapolate the size of unknown molecule(s).

1. Measure and Record Migration Distances

Measure the distance traveled by each Standard DNA Fragment from the lower edge of the sample well to the lower end of each band. Record the distance in centimeters (to the nearest millimeter) in your notebook. Repeat this for each DNA fragment in the standard.

Measure and record the migration distances of each of the fragments in the unknown samples in the same way you measured the standard bands.

2. Generate a Standard Curve

Because migration rate is inversely proportional to the log₁₀ of band length, plotting the data as a semi-log plot will produce a straight line and allow us to analyze an exponential range of fragment sizes. You will notice that the vertical axis of the semi-log plot appears atypical at first; the distance between numbers shrinks as the axis progresses from 1 to 9. This is because the axis represents a logarithmic scale. The first cycle on the y-axis corresponds to lengths from 100-1,000 base pairs, the second cycle measures 1,000-10,000 base pairs, and so on. To create a standard curve on the semi-log paper, plot the distance each Standard DNA fragment migrated on the x-axis (in mm) versus its size on the y-axis (in base pairs). Be sure to label the axes!

Figure 4: Semilog graph example

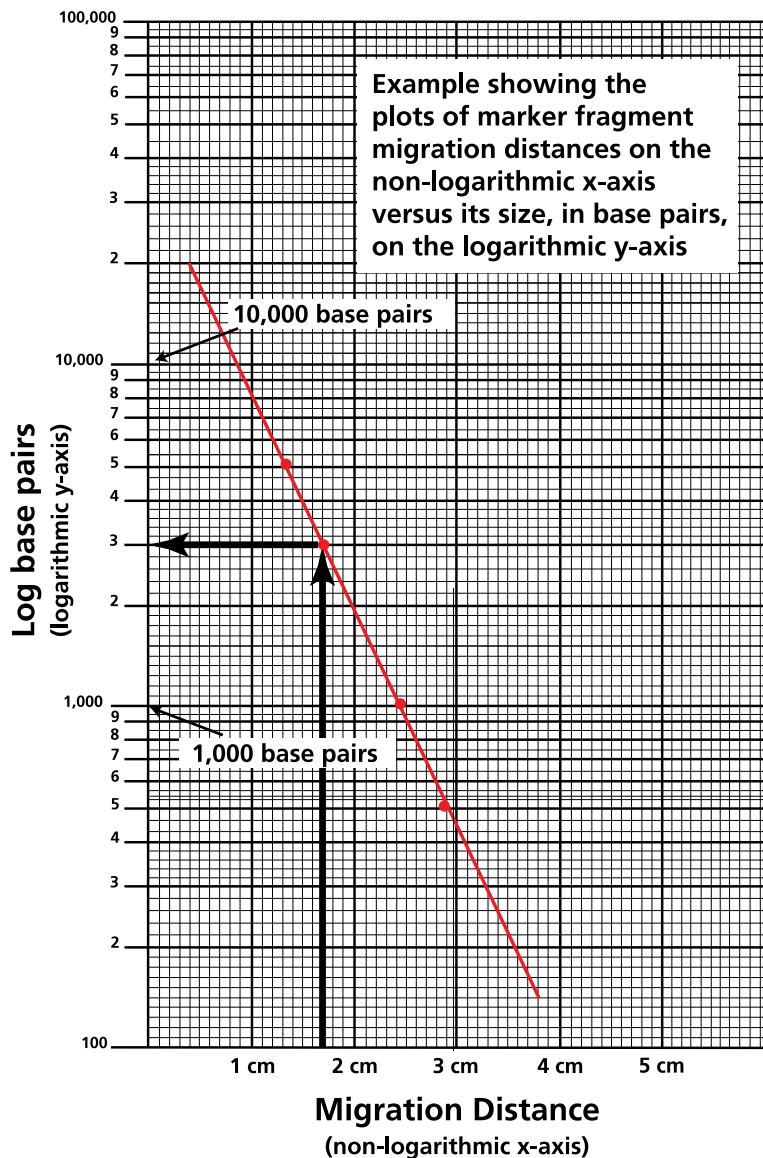

Quick Reference:
 DNA Standard fragment sizes - length is expressed in base pairs.
 6751, 3652, 2827, 1568, 1118, 825, 630

After all the points have been plotted, use a ruler or a straight edge to draw the best straight line possible through the points. The line should have approximately equal numbers of points scattered on each side of the line. It is okay if the line runs through some points (see Figure 4 for an example).

3. Determine the length of each unknown fragment.

- a. Locate the migration distance of the unknown fragment on the x-axis of your semi-log graph. Draw a vertical line extending from that point until it intersects the line of your standard curve.
- b. From the point of intersection, draw a second line, this time horizontally, toward the y-axis. The value at which this line intersects the y-axis represents the approximate size of the fragment in base pairs (refer to Figure 4 for an example). Make note of this in your lab notebook.
- c. Repeat for each fragment in your unknown sample.

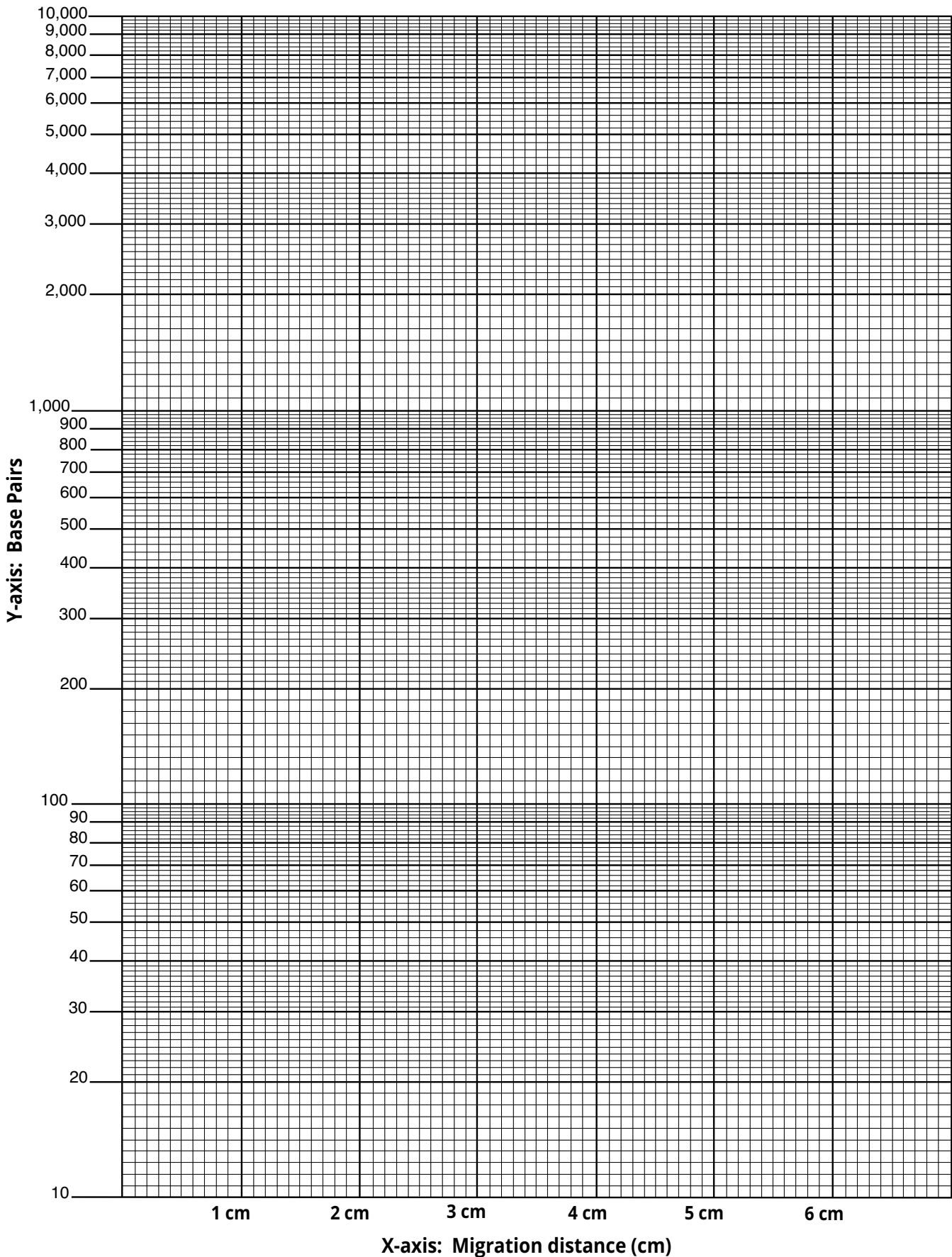

1.800.EDVOTEK • Fax 202.370.1501 • info@edvotek.com • www.edvotek.com

Duplication of any part of this document is permitted for non-profit educational purposes only. Copyright © 1989-2021 EDVOTEK, Inc., all rights reserved. Version 105.210628

Module IV: Mapping of DNA Restriction Sites

The size of the plasmid used in this experiment is 4300 bp.

1. Draw a circle representing a 4300 bp plasmid on a transparent sheet of acetate.
2. Mark the positions of Enzyme #2 (Lane 3) sites corresponding to the sizes of fragments obtained upon digestion of the plasmid on the gel.
3. Draw a second circle representing a 4300 bp plasmid on a transparent sheet of acetate.
4. Mark the position of the Enzyme #1 (Lane 2) site at the top (12:00 o'clock).
5. To draw a composite map of both enzymes, overlay the Enzyme #2 map on top of the Enzyme #1 map.
6. Keeping the Enzyme #1 site at the 12:00 o'clock position, rotate the Enzyme #2 map until the relative distances between the sites approximate the relative sizes of the fragments of Enzyme #1 and #2 combined.
7. Specify, in base pairs, the distances between all the sites.

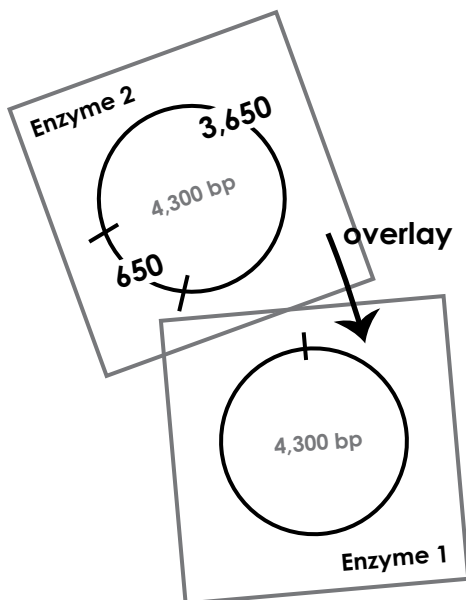

Study Questions

1. Describe DNA mapping and list some important uses for this technology.
2. When plotting the sizes of DNA fragments, which axis is used to plot the migration distances of the known and unknown fragments?

Which axis is used to plot the sizes of the known and unknown fragments?

3. A plasmid DNA was cut with several restriction enzymes and the following fragment sizes were determined by comparing the unknown fragments to a standard DNA marker:

Enzyme 1	3000
Enzyme 2	3000
Enzyme 3	1800 & 1200
Enzymes 1 & 2	1450 & 1550
Enzymes 2 & 3	1800, 650, & 550
Enzymes 1 & 3	1200, 1000, & 800

Draw a restriction map based on the data.

Instructor's Guide

ADVANCE PREPARATION:

PREPARATION FOR:	WHAT TO DO:	WHEN?	TIME REQUIRED:
Module I: Agarose Gel Electrophoresis	Prepare QuickStrips™.	Up to one day before performing the experiment.	45 min.
	Prepare diluted electrophoresis buffer.		
	Prepare molten agarose and pour gels.		
Module II: Staining Agarose Gels Using FlashBlue™	Prepare staining components.	The class period or overnight after the class period.	10 min.

Technical Support

1.800.EDVOTEK

Mon. - Fri. 8 AM to 5:30 PM EST



Please Have the Following Info:

- Product Number & Description
- Lot Number on Box
- Order/Purchase Order #

1.800.EDVOTEK • info@edvotek.com • www.edvotek.com

www.edvotek.com

- Online Catalog
- Order Products
- Experiment Protocols
- Tech Support
- Resources!



NOTE:

Accurate pipetting is critical for maximizing successful experiment results. EDVOTEK Series 100 experiments are designed for students who have had previous experience with micropipetting techniques and agarose gel electrophoresis.

If students are unfamiliar with using micropipettes, we recommended performing [Cat. #S-44, Micropipetting Basics](#) or [Cat. #S-43, DNA DuraGel™](#) prior to conducting this experiment.

Pre-Lab Preparations: Module I

AGAROSE GEL ELECTROPHORESIS

This experiment requires 0.8% agarose gels. Enough reagents are provided to cast either eight 7 x 7 cm gels, eight 10 x 7 cm gels, or four 14 x 7 cm gels. You can choose whether to prepare the gels in advance or have students prepare their own. Allow approximately 30 minutes for this procedure.

Quick Reference for EDVO-Kit #105			
Size of gel casting tray	Groups per gel	Placement of comb	Wells required per group
7 x 7 cm	1 group	1st set of notches	4
10 x 7 cm	1 group	1st set of notches	4
14 x 7 cm	2 groups	1st and 3rd sets of notches	4

Individual Gel Preparation:

Each student group can be responsible for casting their own individual gel prior to conducting the experiment. See Module I in the Student's Experimental Procedure. Students will need 50x concentrated buffer, distilled water and agarose powder.

Batch Gel Preparation:

To save time, a larger quantity of agarose solution can be prepared for sharing by the class. Electrophoresis buffer can also be prepared in bulk. See Appendix B.

Preparing Gels in Advance:

Gels may be prepared ahead and stored for later use. Solidified gels can be stored under buffer in the refrigerator for up to 2 weeks.

Do not freeze gels at -20 °C as freezing will destroy the gels.

Gels that have been removed from their trays for storage should be "anchored" back to the tray with a few drops of molten agarose before being placed into the tray. This will prevent the gels from sliding around in the trays and the chambers.

SAMPLES FORMAT: PREPARING THE QUICKSTRIPS™

QuickStrip™ tubes consist of a microtiter block covered with a protective foil overlay. Each well contains pre-aliquoted sample.

Using sharp scissors, carefully divide the block of tubes into individual strips by cutting between the rows (see diagram at right). Take care not to damage the foil overlay while separating the samples.

Each lab group will receive one set of tubes. Before loading the gel, remind students to tap the tubes to collect the sample at the bottom of the tube. Puncture the foil overlay of the QuickStrip™ with a pipet tip to aspirate the sample. **Do not remove the foil as samples can spill.**

FOR MODULE I Each group will need:

- 50x concentrated buffer
- Distilled Water
- UltraSpec-Agarose™
- QuickStrip™ Samples

NOTE:

This kit is compatible with [SYBR® Safe Stain](#) (Cat #608, not included). Instructions for preparing gels and visualizing results can be found in Appendix C.

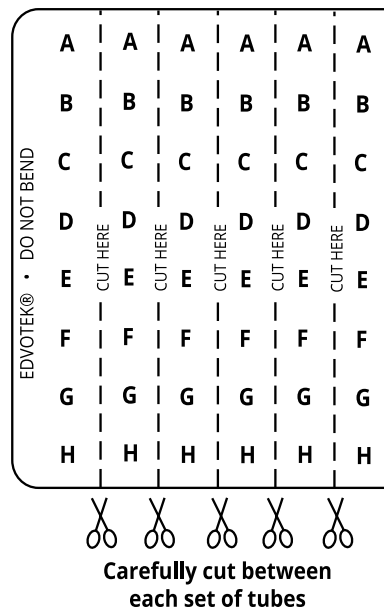

Pre-Lab Preparations: Module II

STAINING AGAROSE GELS USING FLASHBLUE™

FlashBlue™ stain is optimized to shorten the time required for both staining and de-staining steps. Agarose gels can be stained with diluted FlashBlue™ for 5 minutes and destained for only 20 minutes. For the best results, leave the gel in liquid overnight. This will allow the stained gel to “equilibrate” in the destaining solution, resulting in dark blue DNA bands contrasting against a uniformly light blue background. A white light box ([Cat. #552](#)) is recommended for visualizing gels stained with FlashBlue™.

- Stained gels may be stored in destaining liquid for several weeks with refrigeration, although the bands may fade with time. If this happens, re-stain the gel.
- Destained gels can be discarded in solid waste disposal. Destaining solutions can be disposed of down the drain.

FOR MODULE II Each group will need:

- 10 mL 10X concentrated FlashBlue *OR*
100 mL 1x diluted FlashBlue
- Small plastic tray or weight boat
- Distilled or deionized water

PHOTODOCUMENTATION OF DNA (OPTIONAL)

Once gels are stained, you may wish to photograph your results. There are many different photodocumentation systems available, including digital systems that are interfaced directly with computers. Specific instructions will vary depending upon the type of photodocumentation system you are using.

Experiment Results and Analysis

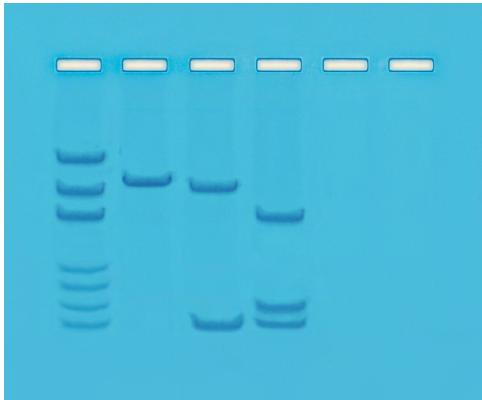

Includes EDVOTEK's All-NEW DNA Standard Marker

- Better separation
- Easier band measurements
- No unused bands

NEW DNA Standard ladder sizes:
6751, 3652, 2827, 1568, 1118, 825, 630

In the idealized schematic, the relative positions of DNA fragments are shown but are not depicted to scale.

Lane	Tube	Sample	Molecular Weights (in bp)
1	A	DNA Standard Markers	6751, 3652, 2827, 1568 1118, 825, 630
2	B	Enzyme 1	4300
3	C	Enzyme 2	3650, 650
4	D	Enzyme 1 & 2	2810, 840, 650

NOTE: This technique has a ±10-15% margin of error.

Referring to Figure B, going in a clockwise direction, the approximate distance, in base pairs between:

Enzyme 1 and nearest Enzyme 2: 840

Enzyme 2 and Enzyme 2: 650

Enzyme 1 and farthest Enzyme 2: 1490

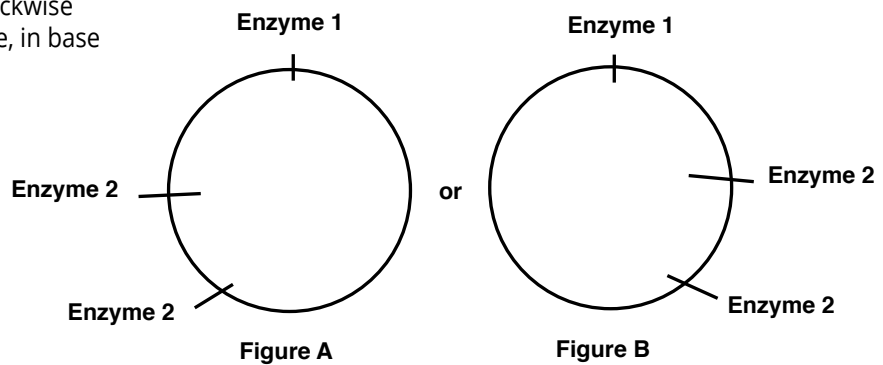

**Please refer to the kit
insert for the Answers to
Study Questions**

Appendices

- A EDVOTEK® Troubleshooting Guide
- B Bulk Preparation of Electrophoresis Buffer and Agarose Gels
- C Using SYBR® Safe Stain (OPTIONAL)

Safety Data Sheets can be found on our website: www.edvotek.com/safety-data-sheets

Technical Support

1.800.EDVOTEK

Mon. - Fri. 8 AM to 5:30 PM EST



Please Have the Following Info:

- Product Number & Description
- Lot Number on Box
- Order/Purchase Order #

1.800.EDVOTEK • info@edvotek.com • www.edvotek.com

www.edvotek.com

- Online Catalog
- Order Products
- Experiment Protocols
- Tech Support
- Resources!



Appendix A

EDVOTEK® Troubleshooting Guides

PROBLEM:	CAUSE:	ANSWER:
Bands are not visible on the gel.	The gel was not prepared properly.	Ensure that the electrophoresis buffer was correctly diluted.
	The gel was not stained properly.	Repeat staining protocol.
	Malfunctioning electrophoresis unit or power source.	Contact the manufacturer of the electrophoresis unit or power source.
After staining the gel, the DNA bands are faint.	The gel was not stained for a sufficient period of time.	Repeat staining protocol.
	The background of gel is too dark after staining with FlashBlue™.	Destain the gel for 5-10 minutes in distilled water.
DNA bands were not resolved.	Tracking dye should migrate at least 3 cm from the wells to ensure adequate separation.	Be sure to run the gel at least 3 cm before staining and visualizing the DNA (approximately 15-20 minutes at 150 V).
DNA bands fade when gels are kept at 4 °C.	DNA stained with FlashBlue™ may fade with time.	Re-stain the gel with FlashBlue™.
There is no separation between DNA bands, even though the tracking dye ran the appropriate distance.	The wrong percent gel was used for electrophoretic separation.	Be sure to prepare the correct percent agarose gel. For reference, the Ready-to-Load™ DNA samples should be analyzed using a 0.8% agarose gel.
There's not enough sample in my QuickStrip™.	The QuickStrip™ has dried out.	Add 40 µL water, gently pipet up and down to mix before loading.

Visit www.edvotek.com for additional troubleshooting suggestions.

Appendix B

Bulk Preparation of Electrophoresis Buffer and Agarose Gels

To save time, the electrophoresis buffer and agarose gel solution can be prepared in larger quantities for sharing by the class. Unused diluted buffer can be used at a later time and solidified agarose gel solution can be remelted.

Bulk Electrophoresis Buffer

Quantity (bulk) preparation for 3 liters of 1x electrophoresis buffer is outlined in Table D.

Table D Bulk Preparation of Electrophoresis Buffer			
50x Conc. Buffer	+	Distilled Water	Total Volume Required
60 mL		2,940 mL	3000 mL (3 L)

Batch Agarose Gels (0.8%)

For quantity (batch) preparation of 0.8% agarose gels, see Table E.

1. Use a 500 mL flask to prepare the diluted gel buffer.
2. Pour 3.0 grams of UltraSpec-Agarose™ into the prepared buffer. Swirl to disperse clumps.
3. With a marking pen, indicate the level of solution volume on the outside of the flask.
4. Heat the agarose solution as outlined previously for individual gel preparation. The heating time will require adjustment due to the larger total volume of gel buffer solution.
5. Cool the agarose solution to 60 °C with swirling to promote even dissipation of heat. If evaporation has occurred, add distilled water to bring the solution up to the original volume as marked on the flask in step 3.
6. Dispense the required volume of cooled agarose solution for casting each gel. Measure 30 mL for a 7 x 7 cm tray, 45 mL for a 10 x 7 cm tray, and 60 mL for a 14 x 7 cm tray. **For this experiment, 7 x 7 cm gels are recommended.**
7. Allow the gel to completely solidify. It will become firm and cool to the touch after approximately 20 minutes. Solidified gels can be stored under buffer in the refrigerator for up to 2 weeks. Do not freeze gels.

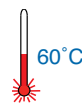

Table E Batch Prep of 0.8% UltraSpec-Agarose™					
Amt of Agarose	+	Concentrated Buffer (50X)	+	Distilled Water	Total Volume
3.0 g		7.5 mL		367.5 mL	375 mL

NOTE:

The UltraSpec-Agarose™ kit component is usually labeled with the amount it contains. Please read the label carefully. If the amount of agarose is not specified or if the bottle's plastic seal has been broken, weigh the agarose to ensure you are using the correct amount.

PROCEED to Loading and Running the Gel (page 10).

Appendix C

Using SYBR® Safe DNA Stain (OPTIONAL)

If desired, the DNA samples in this experiment can be visualized using [SYBR® Safe DNA stain \(Cat #608\)](#).

We recommend adding diluted SYBR® Safe stain to the liquid agarose gels while casting for easy, reproducible results. A blue light or UV transilluminator is needed for visualizing SYBR® gels. The TruBlu™ 2 ([Cat. #557](#)) is highly recommended.

PREPARING SYBR® SAFE STAIN

Instructors:

1. Prepare 1x Electrophoresis Buffer by combining 10 µL of 50X Concentrated Buffer with 490 µL of distilled water.
2. Add 20 µL of the SYBR® Safe to the tube of 1X buffer from Step 1 and mix by tapping the tube several times. The diluted SYBR® Safe Stain is now ready to be used during agarose gel preparation.

AGAROSE GEL PREPARATION

This experiment requires one 0.8% agarose gel for each student group. Instructors can choose whether to prepare the gels in advance (METHOD A) or have the students prepare their own (METHOD B). Allow approximately 30-40 minutes for this procedure.

Instructor Preparation (METHOD A):

For quantity (batch) preparation of agarose gels, see Table E.

1. Use a 500 mL flask to prepare the diluted gel buffer.
2. Pour 3.0 grams of UltraSpec-Agarose™ into the prepared buffer. Swirl to disperse clumps.
3. With a marking pen, indicate the level of solution volume on the outside of the flask.
4. Heat the agarose solution as outlined previously for individual gel preparation. The heating time will require adjustment due to the larger total volume of gel buffer solution.
5. Cool the agarose solution to 60 °C with swirling to promote even dissipation of heat. If evaporation has occurred, add distilled water to bring the solution up to the original volume as marked on the flask in step 3.
6. Add the entire tube of **diluted SYBR® Safe** stain to the cooled agarose and mix well.
7. Dispense the required volume of cooled agarose solution for casting each gel. Measure 30 mL for a 7 x 7 cm tray, 45 mL for a 10 x 7 cm tray, and 60 mL for a 14 x 7 cm tray. **For this experiment, 7 x 7 cm gels are recommended.**
8. Allow the gel to completely solidify. It will become firm and cool to the touch after approximately 20 minutes. Solidified gels can be stored in the refrigerator for up to 2 weeks. Place 1-2 mL of electrophoresis buffer in a sealable bag with the gels to prevent them from drying out. Excessive buffer will cause SYBR® Safe to diffuse out of the gels. Do not freeze gels.

PROCEED to Loading and Running the Gel (Steps 8-12 on page 10), followed by the VISUALIZATION procedures on page 27.

NO ADDITIONAL STAINING IS NECESSARY.

Table E € Batch Prep of 0.8% UltraSpec-Agarose™					
Amt of Agarose	+	Concentrated Buffer (50X)	+	Distilled Water	Total Volume
3.0 g		7.5 mL		367.5 mL	375 mL

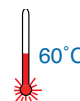

Appendix C

Using SYBR® Safe DNA Stain (OPTIONAL)

AGAROSE GEL PREPARATION, CONTINUED

Student Preparation (METHOD B):

For student preparation of agarose gels, see Table A.2.

1. **DILUTE** concentrated (50X) buffer with distilled water to create 1X buffer (see Table A.2).
2. **MIX** agarose powder with 1X buffer in a 250 mL flask (see Table A).
3. **DISSOLVE** agarose powder by boiling the solution. **MICROWAVE** the solution on high for 1 minute. Carefully **REMOVE** the flask from the microwave and **MIX** by swirling the flask. Continue to **HEAT** the solution in 15-second bursts until the agarose is completely dissolved (the solution should be clear like water).
4. **COOL** agarose to 60 °C with careful swirling to promote even dissipation of heat. 
5. While agarose is cooling, **SEAL** the ends of the gel-casting tray with the rubber end caps. **PLACE** the well template (comb) in the appropriate notch.
6. Before casting the gel, **ADD diluted SYBR® Safe** to the cooled agarose and swirl to mix (see Table A.2).
7. **POUR** the cooled agarose solution into the prepared gel-casting tray. The gel should thoroughly solidify within 20 minutes. The gel will stiffen and become less transparent as it solidifies.
8. **REMOVE** end caps and comb. Take particular care when removing the comb to prevent damage to the wells.

Size of Gel Casting tray	Concentrated Buffer (50x)	Distilled Water	Amt of Agarose	= TOTAL Volume	Diluted SYBR® (Step 6)
7 x 7 cm	0.6 mL	29.4 mL	0.24 g	30 mL	30 µL
10 x 7 cm*	0.9 mL	44.1 mL	0.36 g	45 mL	45 µL
14 x 7 cm	1.2 mL	58.8 mL	0.48 g	60 mL	60 µL

* Recommended gel volume for the EDGE™ Integrated Electrophoresis System.

PROCEED to Loading and Running the Gel (Steps 8-12 on page 10), followed by the VISUALIZATION procedures on page 27. **NO ADDITIONAL STAINING IS NECESSARY.**

Appendix C

Using SYBR® Safe DNA Stain (OPTIONAL)

VISUALIZING THE SYBR® GEL

A blue light or UV transilluminator is needed for visualizing SYBR® gels. The TruBlu™ 2 ([Cat. #557](#)) is highly recommended.

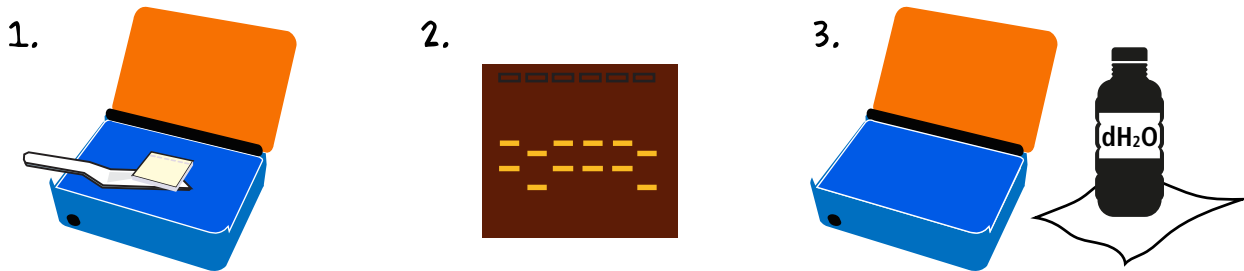

1. **SLIDE** gel off the casting tray onto the viewing surface of the transilluminator.
2. Turn the unit **ON**. DNA should appear as bright green bands on a dark background. **PHOTOGRAPH** results.
3. Turn the unit **OFF**. **REMOVE** and **DISPOSE** of the gel. **CLEAN** the transilluminator surfaces with distilled water.

